

## CONDUCTIVITY SENSOR(K=0.1) with SS Trichlover fitting

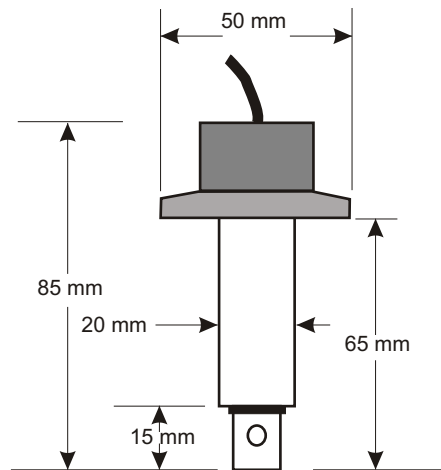

### **TECHNICAL SPECIFICATIONS:**

- |                            |                                   |
|----------------------------|-----------------------------------|
| 1. Overall dimension       | : 85 mm(L) X 50 mm(W)             |
| 2. Diameter of sensor pipe | : 12.5 mm                         |
| 3. Type                    | : Flow through                    |
| 4. Cell constant           | : 0.1                             |
| 5. Electrode material      | : SS 316                          |
| 6. Process connection      | : Trichlover fitting              |
| 7. Integral cable length   | : 10 feet 3 core Teflon insulated |
| 8. Application             | : Water                           |